

USER MANUAL

RainPoint 3-Zone Digital Water Timer

Model No. ITV347

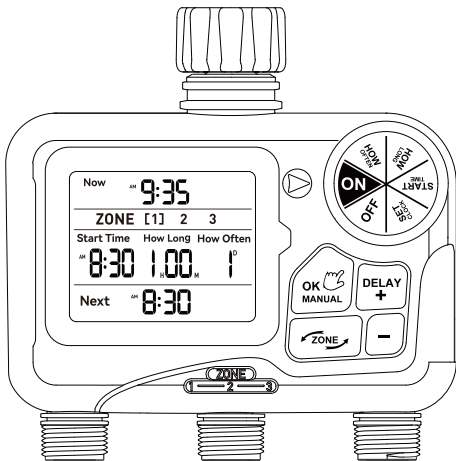

Email:
service@rainpointonline.com



Free Hotline
US toll free: +1 833-381-5659
DE toll free: +49 800-182-0576
UK toll free: +44 800-808-5337

WARM TIPS

PLEASE READ BEFORE USING



Don't use the water timer when the temperature is below 37.4°F (3°C), and please store the timer indoors to avoid potential freezing damage.



The filter traps dirt particles, preventing them from entering the timer and causing clogging. Please clean the filter regularly and replace it if worn.



To ensure a longer lifespan, please use 4 new AA alkaline batteries (not included). Don't mix new and old alkaline, standard (carbon-zinc), or rechargeable batteries.



Please activate the water timer before first use or after a period of inactivity (Refer to page 6: **ACTIVATE THE TIMER BEFORE USE**).



Only use with clean cold water.

FOR ANY PROBLEMS DURING USE, PLEASE GET SUPPORT FROM US:



Web: www.rainpointonline.com



Email: service@rainpointonline.com



US toll free(English): +1 833-381-5659

(Mon-Fri: 9:30 AM-5:30 PM PST)

DE toll free(Deutsch): +49 800-182-0576

(Mon-Fri: 9:00 AM-5:00 PM CET)

UK toll free(English): +44 800-808-5337

(Mon-Fri: 9:00 AM-5:00 PM CET)

OVERVIEW

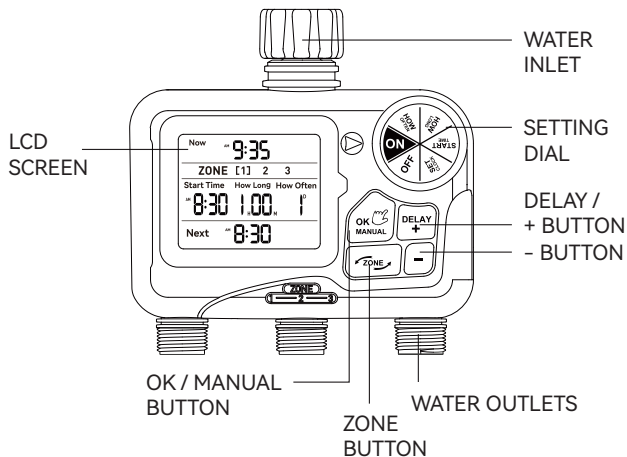

SPECIFICATION

ITEM	SPECIFICATION
Inlet Thread	NH(US) for 3/4" faucet BSP(EU) for 3/4" or 1" faucet
Working Temperature	37.4°F-122°F(3°C-50°C)
Working Water Pressure	0.5bar-8bar(7.25PSI-116PSI)
Time Format	12H/24H
Rain Delay	24/48/72H
Water Frequency	1H-12H, 1Day-7Day
Water Duration	1min-4H
Manual Watering Time	1min-8H
Powered By	4*AA Alkaline batteries (not included)
Waterproof Level	IP65

BUTTON FUNCTION INTRODUCTION



Dial Functions	
Dial	Turn the dial to set the watering plans and save the settings
ON	Run the timer as scheduled
OFF	Turn off the timer
SET CLOCK	Choose 12H/24H time format and set current time
START TIME	Set the time to start watering
HOW LONG	Set the duration of watering plan
HOW OFTEN	Set the frequency of watering plan



Button Functions	
OK/MANUAL BUTTON	Confirm settings or water manually
+/DEALY BUTTON	Adjust settings,choose rain delay time
- BUTTON	Adjust settings,choose rain delay time
ZONE BUTTON	Switch watering zone when setup

BATTERY INSTALLATION

- 1) Remove the battery compartment at the bottom of the timer.
- 2) Insert 4 new AA (1.5V) alkaline batteries(not included).
- 3) Put the battery compartment back to the timer and press firmly to make sure it is completely sealed.

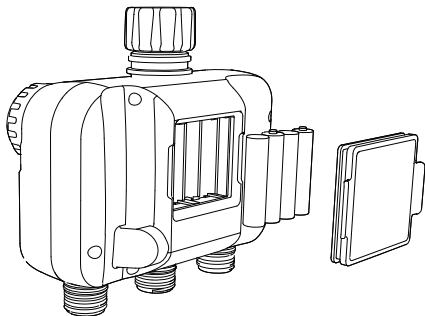

NOTE:

- 1) Install the battery compartment securely after installing the battery to ensure waterproofing.
- 2) When the timer is not used for a long time, please remove the batteries and dispose of them properly.
- 3) Replace batteries when the low battery indicator displays.
- 4) Don't dispose of batteries in fire. Batteries may explode or leak.
- 5) To ensure a longer lifespan, please use 4 new AA alkaline batteries (not included). Don't mix new and old alkaline, standard (carbon-zinc), or rechargeable batteries.

INSTALL THE TIMER ON THE FAUCET

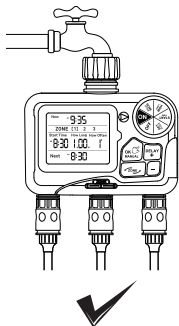

- 1) Turn off the garden faucet.
- 2) Screw the timer to the garden faucet and make the display as vertical as possible to the ground to prevent rainwater from accumulating and leaking into the interior.
- 3) Screw the garden hose to the timer outlet.
- 4) Turn on the faucet after programming the timer.

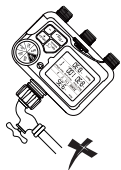
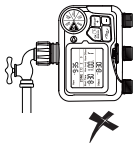

Tips: If a leak occurs due to stripped threads or damaged chamfer at the faucet, wrap teflon tape clockwise around the external threads (2-3 turns) until watertight.

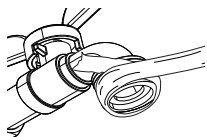

Note:

- ⊗ Please do not use tools, only install the timer by hand.
- ⊗ When freezing temperatures are expected, timers should be removed from the hose faucet and stored indoors to prevent potential freeze damage.
- ▲ Please install the filter properly and keep it clean as follows.

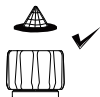

ACTIVATE THE TIMER BEFORE USE

- ▲ Please active the valves when getting the timer for the first time, or it's been a long time since your last time to use it.

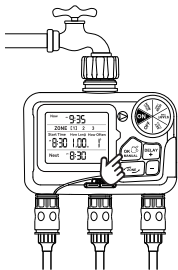

- 1) Keep the faucet off and turn the dial to "ON".
 - 2) Press and hold the "OK/MANUAL" button and at the same time insert the batteries to enter the self-inspection mode.
 - 3) Release "OK/Manual" button 3 secs later and all the valves will be opened and closed in turn to finish self-inspection, each valve costs 5 secs.
 - 4) After all of the zones finished the first self-inspection, turn on the faucet a little bit to start test with water.
- 5) During test of each valve, please check whether the water flows out or shuts off as expected.
If yes, the timer valves are activated successfully, please use the timer with confidence.
If not, please repeat the testing steps for several times, or contact us immediately for support.
- 6) After test, take out the batteries to avoid testing circlly. Then re-insert batteries to start normal operation.

Note:

When testing, please keep away from the water timer outlet to avoid being splashed and wet.

PROGRAMMING THE TIMER

This three-zone timer allows you to water three different areas using a single faucet, with each zone customizable for independent start times, irrigation durations, and frequencies.

NOTE:

1) Single Zone Operation:

The device can only run one zone's program at a time; running multiple zones simultaneously will split and reduce water pressure. If there are conflicting programs, only one zone will execute while others wait for completion. More information please refer to P19.

2) Setup Instructions:

Setting Watering Plans for Each Zone: Press the "ZONE" button to select ZONE 1. Set the start time, duration, and frequency of ZONE 1, then turn the dial to "ON" to save the changes. And the watering plan for ZONE 1 has been set successfully. Use the "ZONE" button to select ZONE 2, or ZONE 3, and use the same method to set the watering plans for each zone.

Watering Plans:

Each zone can set only one watering plan.

STEP 1: SET CLOCK

Now	24H

Now	12:30

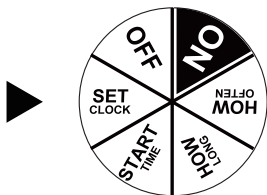

- 1) Turn the dial to "SET CLOCK". Use the "+" or "-" buttons to select either the 24H or 12H format, then press the "OK" button to confirm and enter the time setting.
- 2) The hour number flashes. Use the "+" or "-" buttons to adjust the number to your local time. If you choose the 12H format, please be aware of the distinction between AM and PM.
- 3) Use the "OK" button to confirm and switch between hours, minutes, or 12H/24H formats.
- 4) Rotate the dial clockwise to save the changes, then proceed to the next step.

NOTE:

- 1) When completing this step, please turn the dial to save changes instead of pressing the "OK" button. If you press "OK" after setting, it will return to previous settings instead of saving them.
- 2) Press and hold "+" or "-" buttons for 3 secs can adjust number quickly.

STEP 2: START TIME

Now	18:00		
ZONE [1]	2	3	
Start Time	How Long	How Often	
8:00	0 _H 10 _M	1 ^D	

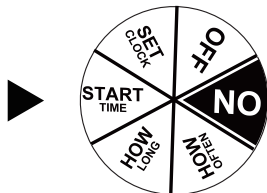

- 1) Turn the dial to "START TIME".
- 2) The hour flashes; use the "+" and "-" buttons to set your start time.
- 3) Use the "OK" button to switch between hours or minutes.
- 4) Rotate the dial clockwise to save the changes and proceed to the next step.

More information please turn to Page 19 to learn the running logic of the valves in each zone of the timer.

To learn how to close one or several zones, please refer to Page 17 in this manual.

NOTE:

Press and hold "+" or "-" buttons for 3 secs can adjust number quickly.

STEP 3: HOW LONG

Now	18:00		
ZONE [1] 2 3			
Start Time	How Long	How Often	
8:00	0 _H 10 _M	1 ^D	

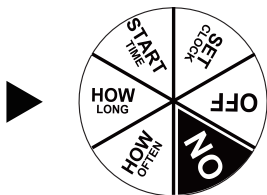

- 1) Turn the dial to "HOW LONG".
- 2) The hour flashes. Use the "+" and "-" buttons to select the watering duration, ranging from 1 minute to 4 hours.
- 3) Use the "OK" button to confirm and switch between hours or minutes.
- 4) Rotate the dial clockwise to save the changes and proceed to the next step.

NOTE:

- 1) Press and hold "+" or "-" buttons for 3 secs can adjust number quickly.
- 2) As the setting range for "HOW LONG" is from 1 minute to 4 hours, and the setting range for "HOW OFTEN" is from 1 hour to 12 hours or 1 day to 7 days, **it's important to ensure that the "HOW OFTEN" setting is equal to or longer than the "HOW LONG" setting. This ensures that the plan functions correctly; otherwise, it may not operate as intended.**

STEP 4: HOW OFTEN

Now	18:00		
ZONE [1] 2 3			
Start Time	How Long	How Often	
8:00	0 _H 10 _M	1 ^D	

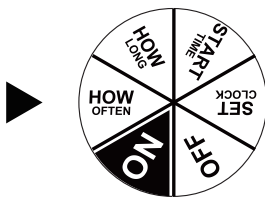

- 1) Turn the dial to "HOW OFTEN".
- 2) Use the "+" and "-" buttons to set your watering frequency. You can choose every 1 to 12 hours or every 1 to 7 days.
- 3) Rotate the dial clockwise to save the changes and proceed to the next step.

More information please turn to Page 20 to learn the logic of the watering frequency.

NOTE:

Press and hold "+" or "-" buttons for 3 secs can adjust number quickly.

STEP 5: AUTOMATIC WATERING

Now	18:00		
ZONE	[1]	2	3
Start Time	How Long	How Often	
8:00	0 _H 10 _M	1 ^P	
Next	8:00		

Next Plan For Zone 1

Now	18:00		
ZONE	1	[2]	3
Start Time	How Long	How Often	
12:00	0 _H 10 _M	1 ^P	
Next	12:00		

Next Plan For Zone 2

Now	18:00		
ZONE	1	2	[3]
Start Time	How Long	How Often	
16:00	0 _H 10 _M	1 ^P	
Next	16:00		

Next Plan For Zone 3

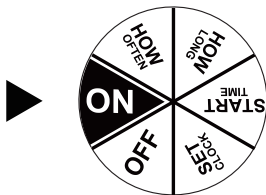

- 1) Turn the dial to "ON".
- 2) The LCD will display the current time and automatically switch to show program details for each of the three zones.

CONGRATULATIONS!

Your timer has now been programmed successfully. It will start watering automatically based on the programmed start time, duration and frequency.

Now you can keep the faucet turned on and trust the timer to do the watering!

ADDITIONAL FUNCTIONS

Manual Watering

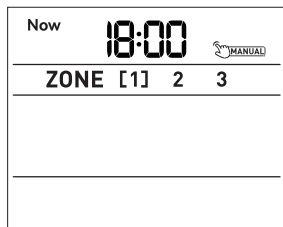

select ZONE 1

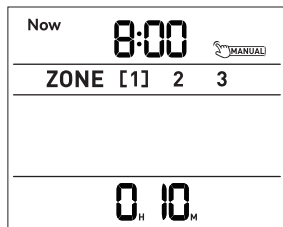

manual water duration setting

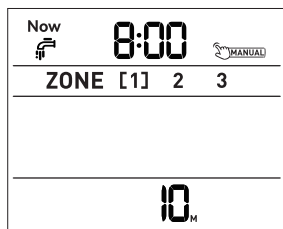



manual watering

Please read the entire operation process before setting. You have 5-7 seconds for each step, and inactivity for 7 seconds will exit the settings interface.

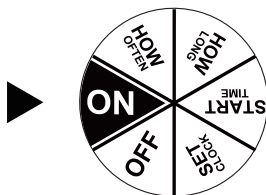
- 1) Turn the dial to "ON".
- 2) Press and hold the "MANUAL" button for 3-5 seconds to enter manual watering mode.



- 3) Press the "Zone" button to select the zone to be watered and then press the "OK" button to confirm. (Note: Only one zone can be selected for watering in manual mode to ensure proper water pressure)
- 4) Use the "+" or "-" buttons to select watering duration, from 1 minute to 8 hours
- 5) Press the "OK" button to start manual watering. The screen will show the parten  and  the remaining timer for manual watering.
- 6) To stop manual watering, press and hold the "MANUAL" button for 3-5 seconds and it will stop manual watering and restore the original watering program.

NOTE:

- 1) Remember to press the "OK" button after setting the manual watering duration in order to start manual watering; otherwise, the manual watering settings will automatically exit after approximately 5-8 seconds of flashing on-screen.
- 2) If you do not select a zone and press "OK" to enter the manual watering time setting, then press "OK" again to start manual watering, zone 1 will be activated for watering since you haven't selected any specific zone.

Note:

Manual watering mode always takes priority over automatic watering mode.

- For a zone, when it's running an automatic watering, a manual watering with later start time conflicts with it, no matter comes from the same or a different zone, then automatic watering would be interrupted and lose its left watering time.
- For a zone, when it's running a manual watering mode, an automatic watering with later start time conflicts with it, automatic watering mode would be skipped no matter it's from the same zone or from another zone.

RAIN DELAY

Now	8:00
24H	Delay

Now	8:00
ZONE [1] 2 3	
Start Time	How Long How Often
8:00	0 _H 10 _M 1 ^P
23 _H 59 _M	Delay

- 1) When dial at "ON", press and hold "+/DELAY" button for 3 sec to enter into rain delay mode interface.
- 2) When default time "24H" is flashing, press "+" and "-" buttons to adjust time between 0H, 24H, 48H and 72H. Select 0H means cancel delay mode.
- 3) Press "OK/Manual" button, and it will start rain delay program immediately.



NOTE:

- 1) After selecting the rain delay duration, you need to press the "OK" button to activate the rain delay program. Otherwise, the rain delay settings will automatically exit after flashing on the screen for 3-5 seconds.
- 2) Rain delay mode cannot be paused once started. To stop the rain delay program, press and hold the "DELAY" button to stop the rain delay program and restore the original watering program. (Alternatively, you can turn the dial to "OFF" and then turn it back to "ON" to resume the original watering program.)
- 3) The rain delay setting is applied to all of the three zones at the same time. If you set the rain delay program for one zone, the plans for the other two zones will be delayed as well.

CLOSE ONE/TWO OF THE ZONES

Now	8:00		
ZONE [1] 2 3			
Start Time	How Long	How Often	
OFF	0 _H 10 _M	1 ^P	

Setting Process

Now	8:00		
ZONE [1] 2 3			
Start Time	How Long	How Often	
OFF	0 _H 10 _M	1 ^P	
OFF			

Setting Finished

If you want to use one or two of the three zones for watering and close the other zone(s), please refer to the following steps to close ZONE 1 and you can close the other zones using the same method.

- 1) Turn the dial to "START TIME" and press "ZONE" to select ZONE 1.
- 2) The hour flashes. Press the "+" or "-" button to adjust the hour until it displays "OFF".
- 3) Turn the dial to "ON" to save the changes and you will see the screen display the start time as "OFF" of ZONE 1 on the main page.

OFF MODE

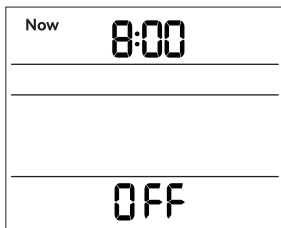

- 1) If you wish to stop all watering plans for an extended period, turn the dial to "OFF".
- 2) The timer will not water automatically while in **OFF** mode, but timer still saves your setted programs. Once you turn the dial to "ON", the setted programs will work again.

Note:

Your automatic watering schedule will only run if the dial is at **ON**.

BATTERY STATUS

 low power icon

Note: When the batteries don't have enough power, the low battery icon will shown on the screen, please change batteries as soon as possible.

WORKING IN DIFFERENT PROGRAMS

Automatic Watering for 3 Zones

Your Timed Watering Plan			Real Working	
Valve	Start Time	How Long	Real Start Time	Finish Watering Time
Zone 1	7:00	20 minutes	7:00	7:20
Zone 2	7:00	20 minutes	7:20	7:40
Zone 3	6:00	20 minutes	6:00	6:20

To ensure output water volume and water pressure from faucet don't reduce, timer will always only open one valve at a time when multi-zones are running at the same time. In this case, a valve with the earliest start time would run firstly. When zones have same start time, then timer would open valve one by one according to the zone number 1-2-3.

For example as above:

- 1) Zone 3 has the earliest start time in all 3 zones, so zone 3 would run firstly.
- 2) Both zone 1 and 2 have secondly earliest start time, and they would run next. Zone 1 secondly and zone 2 thirdly.

Different Watering Frequency

Start time	How often	How timer works in different frequency	Next Start time	-
8:00 AM	8H	Next start time = start time + 8H	16:00 PM	...
8:00 AM	12H	Next start time = start time + 12H	20:00 PM	...
8:00 AM	1 Day	Next start time = start time + 1 Day	8:00 AM every day	...
8:00 AM	2 Day	Next start time = start time + 2 Day	8:00 AM 2 days later	...
8:00 AM	3 Day	Next start time = start time + 3 Day	8:00 AM 3 days later	...

In automatic mode, what will timer work in different watering frequency ?

For example as above:

It shows the start time and next start time when you choose different "How often", namely watering frequency.

Examples of watering frequency of every 1 day, every 2 days and every 3 days:

EVERY 1 DAY



EVERY 2 DAY



EVERY 3 DAY



Timed Watering meets Manual Watering

Valve	Start Time	How Long	Mode	Really Run
Zone 1	7:00	20 minutes	Timed watering mode every day	Run automatic watering program from 7:00~7:10
Zone 2	7:10	30 minutes	Manual watering mode only today	Run manual watering program from 7:10~7:40
Zone 3	7:30	20 minutes	Timed watering mode every day	Run automatic watering program from 7:30~7:50 the next day

Manual watering mode always has the priority over timed watering mode.

For example as above:

- 1) Zone 1 start automatic watering program at 7:00, and its' original end time is at 7: 20. However, zone 2 start manual watering mode at 7:10, which is earlier than 7:20, then timer would open zone 2 to run manual watering program from 7:10~7:40, and zone 1 would be closed from 7:10~7:20, which means zone 1 would lose 10 minutes' watering time.
- 2) After zone 2 finish manual watering at 7:40, zone 3 will skip the timed watering for today as the start time for the automatic watering has passed and it will start the automatic watering the next day at 7:30 after zone 1 and zone 2 finish the watering.

TROUBLESHOOTING

Problem	Possible Factors	Solution may help
Condensation on the screen	<ul style="list-style-type: none"> • Air condenses inside the screen due to the difference in temperature between inside and outside. 	<ul style="list-style-type: none"> • The fog will disappear as the temperature rises, or leave it stand for a period of time.
Low water pressure	<ul style="list-style-type: none"> • Filter blockage. • Inlet pressure is not sufficient to support watering needs. 	<ul style="list-style-type: none"> • Check if the filter is clogged, if so, clean or replace the filter. • Make sure the timer is installed properly and not cross-threaded. • Install a booster pump or other booster pressurizing equipment.
Timer does not water or has low water flow	<ul style="list-style-type: none"> • Batteries are low. • The dial does not turn to ON. • The faucet is not turned on. 	<ul style="list-style-type: none"> • Replace brand new alkaline batteries. • Turn the knob of the dial to the ON position. • Turn on the faucet.
Timer is leaking	<ul style="list-style-type: none"> • Filter washer lost or damaged. 	<ul style="list-style-type: none"> • Check if filter washer is in place. • Check if filter washer is clean and undamaged. • Faucet connection is hand tight.

If you need help in using the timer, please feel free to contact us.

Email: service@rainpointonline.com

US toll free: +1 833-381-5659 (Mon-Fri: 9:30 AM-5:30 PM PST)

DE toll free: +49 800-182-0576 (Mon-Fri: 9:00 AM-5:00 PM CET)

UK toll free: +44 800-808-5337 (Mon-Fri: 9:00 AM-5:00 PM CET)

WARNINGS

- 1) Intended for outdoor use only, put in the sheltered outdoor will prolong the product lifetime.
- 2) Using tools to secure the timer can lead to over-tightening and damage to the timer. Please do not use tools to install the timer; it is recommended to secure it by hand.
- 3) Please ensure that the filter is placed horizontally in the top connector before installation to prevent leakage, add a filter and thread seal tape if necessary.
- 4) The mesh filter can prevent dirt particles. To extend the lifespan of the hose timer, please clean the filter regularly and replace it when worn.
- 5) When the power is low, please replace the batteries in time to avoid the interruption of the normal operation; when replacing the batteries, please make sure that the battery compartment is dry.
- 6) When not in use, please remove the batteries, drain the water from the timer and store it indoors to avoid freezing.
- 7) Do not use the timer when the temperature is above 50°C (122°F) or below 3°C (37.4°F).
- 8) Do not subject the product to extreme force and shock.
- 9) Severe electrical shock could result if water is sprayed into outlets or sources of electrical current. Never immerse the product in water.

WARRANTY

RainPoint provides a 1-year worry-free warranty against manufacturing defects in materials and workmanship from the date of purchase. During the warranty period, we'll replace free of charge the product found to be defective under reasonable use and service as determined solely by RainPoint.

To place a warranty request, please email your order ID to **service@rainpointonline.com** and we'll respond within 24 hours.

CUSTOMER SERVICE

Still have trouble with setup, please search for "RainPoint" on YouTube for installation videos !

If the user manual doesn't have what you're looking for or you need some help, please prepare the LOT NO. of your device and contact us before returning the product to the store.

LOT NO.: XXXXX (on the back of the timer)

US toll free: +1833-381-5659 (Mon-Fri: 09:30 AM-5:30 PM PST)

DE toll free: +49 800-182-0576 (Mon-Fri: 09:00 AM-5:00 PM CET)

UK toll free: +44 800-808-5337 (Mon-Fri: 09:00 AM-5:00 PM CET)

Email: service@rainpointonline.com

EC REP

NAME: VIAJE ELECTRONIC COMPANY LIMITED

ADDRESS: E588, 13 ADELAIDE ROAD, DUBLIN, D02 P950, IRELAND

Email: VIAJEELE@outlook.com

UK REP

NAME: SUJE ELECTRONIC COMPANY LIMITED

ADDRESS: S211 92a Bury Old Road, Manchester, England, M45 6TQ

EMAIL: SUJEELECTRONIC@outlook.com

MANUFACTURER/HERSTELLER/FABRICANT/PRODUTTORE/FABRI-
CANTE:

FUJIAN BALDR TECHNOLOGY CO.,LTD

ADDRESS/ADRESSE/ADRESSE/INDIRIZZO/DIRECCIÓN: Floor 3,
Building 2, No.71 Yangqi Road, Fuwan Industrial Area Cangshan
District, Fuzhou, China. 350008

Email: service@rainpointonline.com

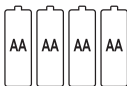

Not included



Points de collecte sur www.quefairedesdechets.fr
Privilégiez la réparation ou le don de votre appareil !



Scan the QR code to get fast support

Need Help?

Please contact us

US toll free: +1 833-381-5659

(Mon-Fri: 9:30 AM-5:30 PM PST)

DE toll free: +49 800-182-0576

(Mon-Fri: 9:00 AM-5:00 PM CET)

UK toll free: +44 800-808-5337

(Mon-Fri: 9:00 AM-5:00 PM CET)

Email: service@rainpointonline.com

